

DP Ergänzungssatz / constant plus additional kit

Ergänzungssatz zur Elektroanlage für Anhängervorrichtung 13pol.

Einbauanleitung / Installation instruction



Art.-Nr.: / Part number

335 025 300 113 (DENG-00784-17)

Gewicht: / Weight:

1,0 kg

Montagezeit: / Installation time:

1,5 Stunden / hours

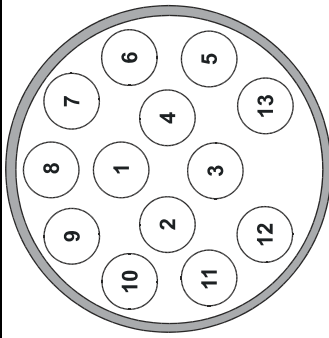

	D	F	GB	I	NL	CZ	E	P	GR	S	H	PL
DIN 11446												
	1 (L)											
	2 (54g)											
	3 (31)											
	4 (R)											
	5 (58-R)											
	6 (54)											
	7 (58-L)											
	8											
	9	rot	red	rosso	rood	červená	rojo	vermelho	κόκκινο	röd	červená	czerwony
	10	gelb	yellow	giallo	geel	žlutá	amarillo	amarelo	κίτρινο	gul	žltá	żółty
	11	braun/ weiß	brown/ white	marrone/ bianco	bruin/wit	hnědobílá	marrón/ blanco	marron/ branco	καφέ/ λευκό	brun/wit	hnědá/ biela	brązowo/ biały
	12											
	13											

D

Montage durch Fachwerkstatt erforderlich.

Massekabel von Batterie abklemmen.

Zur Vermeidung von Beschädigungen an der Kabelisolation ist Berührung mit scharfen Kanten zu vermeiden.

Teile gemäß Abbildung montieren.

Batterie wieder anschließen.

Paneele wieder anbringen; achten Sie darauf, daß der Kabelbaum und andere Teile ordnungsgemäß und genau positioniert sind.

GB

Expert Fitment Required.

Disconnect the battery earth cable

To avoid damage to the wiring harness, ensure contact with sharp edges is prevented.

Install parts as shown on illustrations.

Re-connect battery.

Re-fit panels, ensure that the wiring harness and other components, are neatly and securely located.

NL

Montage door vakman nodig.

Massakabel van accu losmaken.

Ter vermijding van beschadigingen aan de isolatie van de elektrokit dient contact met scherpe kanten te worden vermeden.

Delen overeenkomstig afbeelding monteren.

Accu weer aansluiten.

Panelen weer monteren; let erop, dat de kabelboom en andere delen correct en netjes gepositioneerd worden.

P

Especialista em montagem requerido.

Separe o cabo de terra do acumulador.

Para não de danificar a isolação dos cabos, é conveniente evitar-se contacto com arestas afiadas.

Monte as partes conforme ilustrado.

Recolocar a bateria.

Tornar a colocar os painéis ; verificar se a árvore de cabos e outras peças estão na posição exacta e prescrita.

F

Montage par spécialiste nécessaire.

Débrancher le câble de masse de la batterie.

Eviter tout contact avec des arêtes vives afin de ne pas endommager l'isolation des câbles.

Monter les pièces selon les figures.

Reconnecter la batterie.

Remettre le panneau; veillez à ce que le faisceau et les autres pièces soient positionnés correctement et avec la précision requise.

I

E' necessario in officina specializzata.

Staccare il cavo di massa dalla batteria.

Allo scopo di evitare danni all'isolazione dei cavi, evitare di metterli a contatto con spigoli acuti.

Montare le parti secondo quanto rilevabile delle illustrazioni.

Riconnettere la batteria.

Rimettere in posizione i pannelli; far ben attenzione che il fascio di cavi e le altre parti siano state posizionate con esattezza e nella dovuta maniera.

E

Montaje sólo por el concesionario.

Desconectar el cable de masa de la batería.

A efectos de evita desperfectos en el aislamiento del cable, hay que evitar el contacto con aristas cortantes.

Montar las piezas tal como se indica en las figuras.

Vuelva a conectar la batería.

Volver a colocar los paneles; preste atención a que el mazo del cable y las demás piezas tengan la posición correcta y precisa.

GR

Να τοποθετεί από συνεργείο.

Αποσυνδέστε το καλώδιο γείωσης από τη μπαταρία.

Για να αποφευχθούν ζημιές στη μονωση καλωδίων, να αποφεύγεται η επαφή των με αιχμηρές ακμές.

Τοποθέτηση των μερών σύμφωνα με τις Εικονες.

Συνδέστε πάλι τη μπαταρία.

Τοποθετήστε πάλι το κάλυμμα προσοχή, η πλεξούδα καλωδίων και άλλα μέρη να είναι τοποθετημένα ακριβώς και σύμφωνα με τους κανονισμούς.

CZ

Montáž ve specializované dílně nutná.

Odpjte zemnicí kabel od baterie.

Zabraňte tomu, aby se kabely poškodily tím, že jsou položeny na ostrých hranách.

Montujte části podle vyobrazení.

Opět připojit baterii.

Opět připevněte panely; dbejte na to, aby na svazek kabelů a ostatní části byly uloženy na správném místě.

H

A szereléshez szakműhely kell.

Húzza le az akkumulátor testkábéljét.

A kábelszigetelés megsérülésének elkerülésére ügyeljen arra, hogy a kábel ne juthasson érintkezésbe éles peremű alkatrészekkel.

Az alkatrészeket az ábrák szerint szerelje be.

Ismét csatlakoztassa az akkumulátort.

Szerelje vissza a fedőlapokat, ügyeljen arra, hogy a kábelek és a többi alkatrész pontosan a számukra kijelölt helyen maradjanak.

S

Verkstadsmontage erfordras.

Lossa stomkabeln från batteriet.

För att förhindra skador på ledningarnas isolation skall beröring med vassa kanter undvikas.

Montera detaljerna enligt figurerna.

Anslut batteriet igen.

Sätt tillbaka panelerna igen; kontrollera noga att ledningsmattan och andra detaljer ligger på rätt plats.

PL

Konieczny montaż przez warsztat specjalistyczny.

Odłączyć przewód masy od akumulatora.

Dla zapobieżenia uszkodzeniu izolacji chronić przed zetknięciem z ostrymi krawędziami.





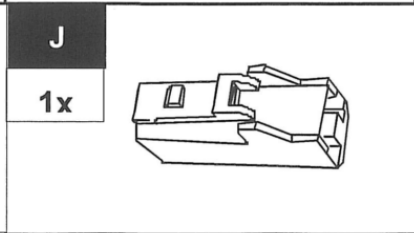
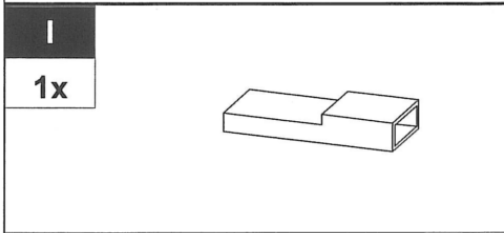
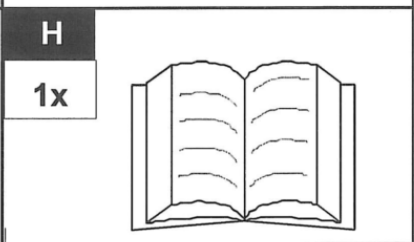
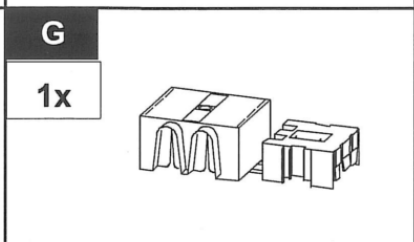
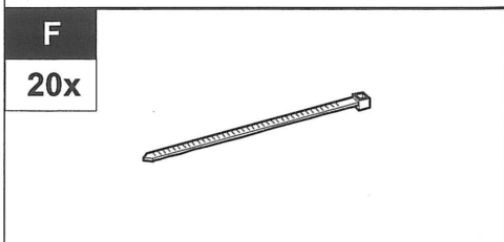
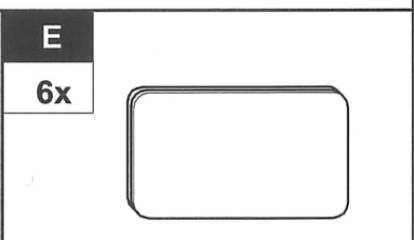
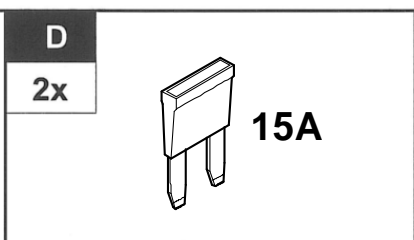
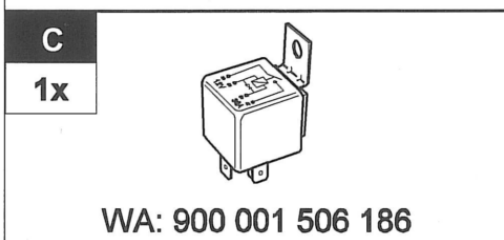
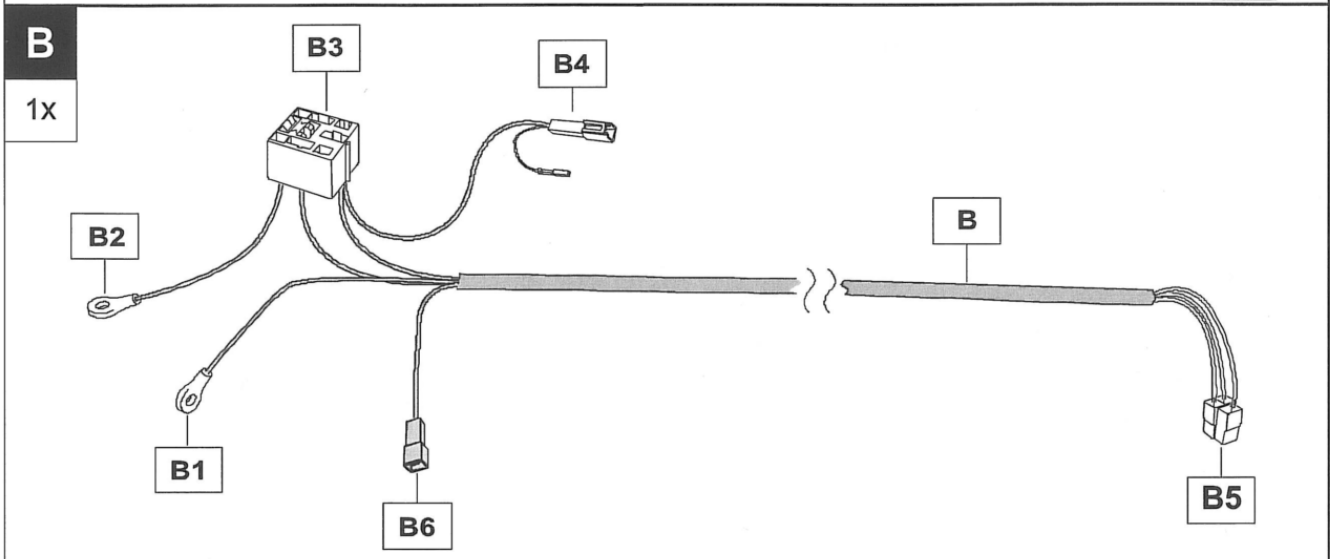
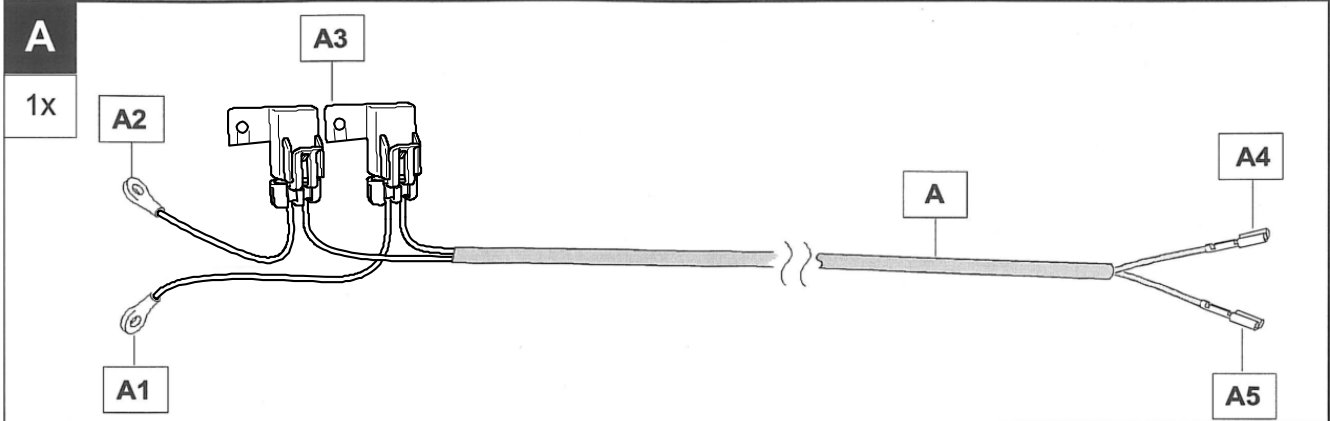

Zamontować części zgodnie z rysunkiem.

Ponownie podłączyć akumulator.

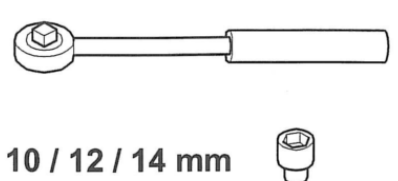
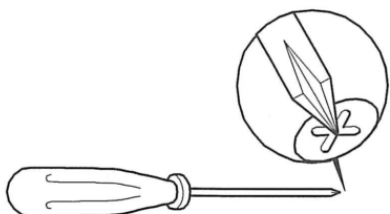
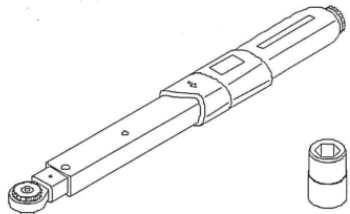
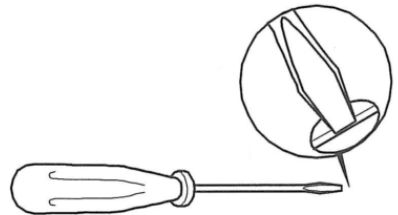
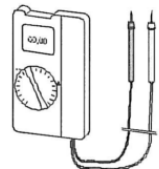
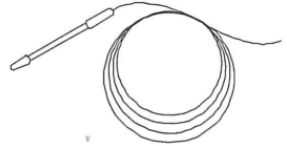
Na powrót osadzić osłony; zadbać aby wiązka kablowa i inne części były właściwie i dokładnie ułożone.

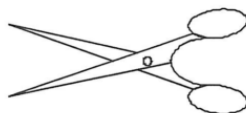
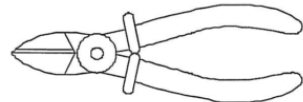
	D	F	GB	I	NL	CZ	E	P	GR	S	H	PL
sw	Schwarz	Noir	Black	Nero	Zwart	Černá	Negro	Preto	μαύρο	Svart	Fekete	Czarny
rt	Rot	Rouge	Red	Rosso	Rood	Červená	Rojo	Vermelho	κόκκινο	Röd	Piros	Czerwony
gn	Grün	Vert	Green	Verde	Groen	Zelená	Verde	Verde	πράσινο	Grön	Zöld	Zielony
or	Orange	Orange	Orange	Arançione	Oranje	Oranžová	Naranja	Laranja	Πορτοκαλί	Orange	Narancs	Poma- rańczowy
vt	Violett	Violet	Violet	Viola	Violet	Fialová	Violeta	Violeta	Μοβ	Violett	Ibolya	Fioletowy
pk	Pink	Rose	Pink	Rosa	Paars	Růžová	Pink	Cor-de- Rosa	Ροζ	Rosa	Rózsaszín	Różowy
bl	Blau	Bleu	Blue	Blu	Blauw	Modrá	Azul	Azul	Μπλε	Blå	Kék	Niebieski
ge	Gelb	Jaune	Yellow	Giallo	Geei	Žlutá	Amarillo	Amarelo	κίτρινο	Gul	Sárga	Zólty
ws	Weiß	Blanc	White	Bianco	Wit	Bílá	Blanco	Branco	λευκό	Vit	Fehér	Biały
br	Braun	Brun	Brown	Marrone	Bruin	Hnědá	Marrón	Marrom	Καφέ	Brun	Barna	Brazowy
gr	Grau	Gris	Grey	Grigio	Grijs	Šedá	Gris	Cinzeno	γκρι	Grå	Szürke	Szary

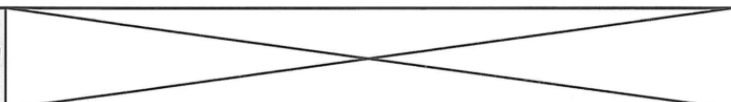

	 10 / 12 / 14 mm		
			
			
1			
	10 mm 		

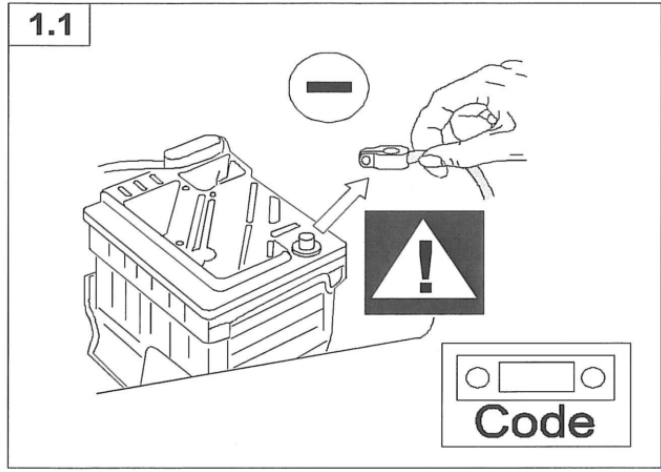



Verlegebeispiel / Routing

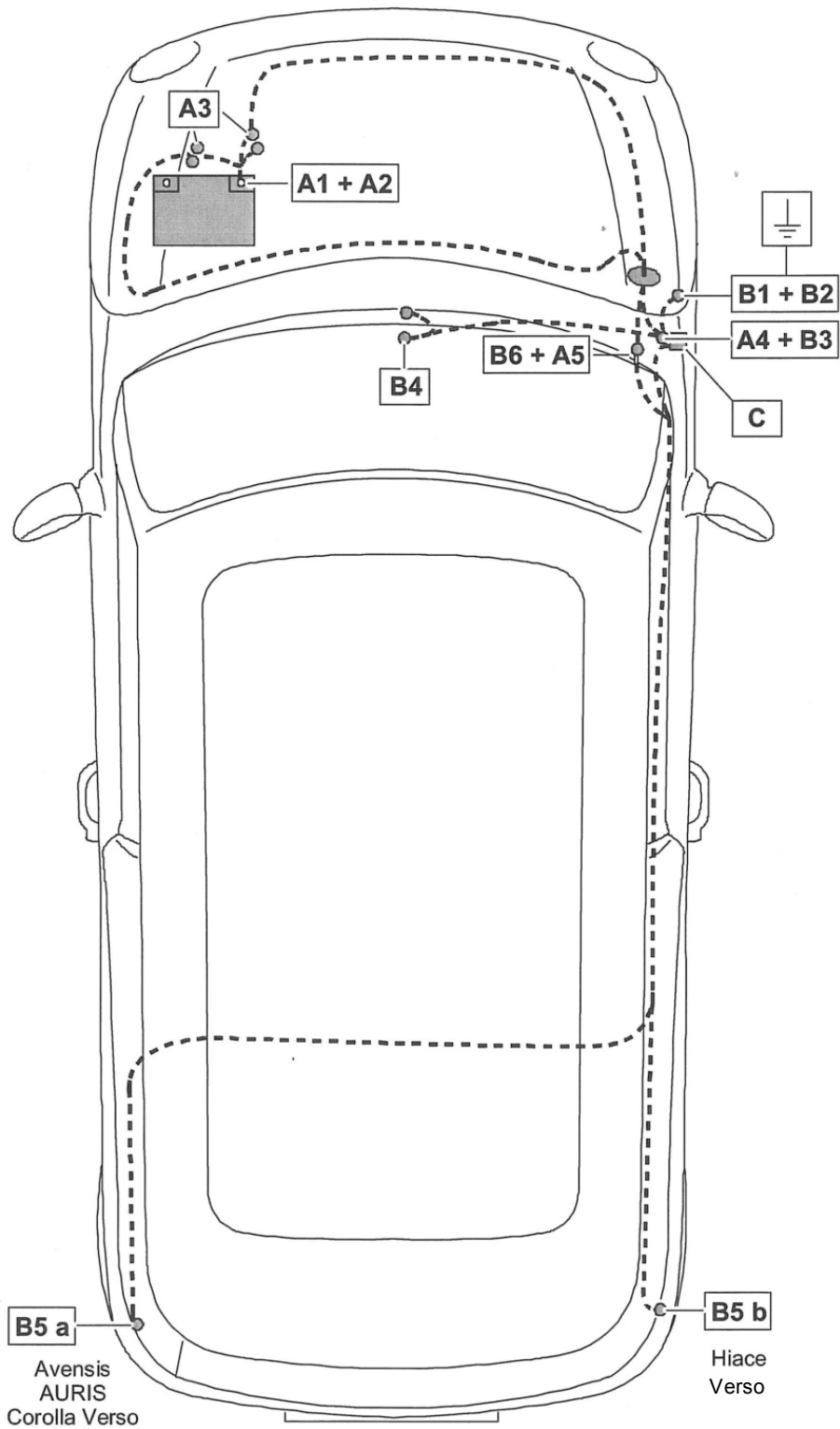



Verlegebeispiel / Routing

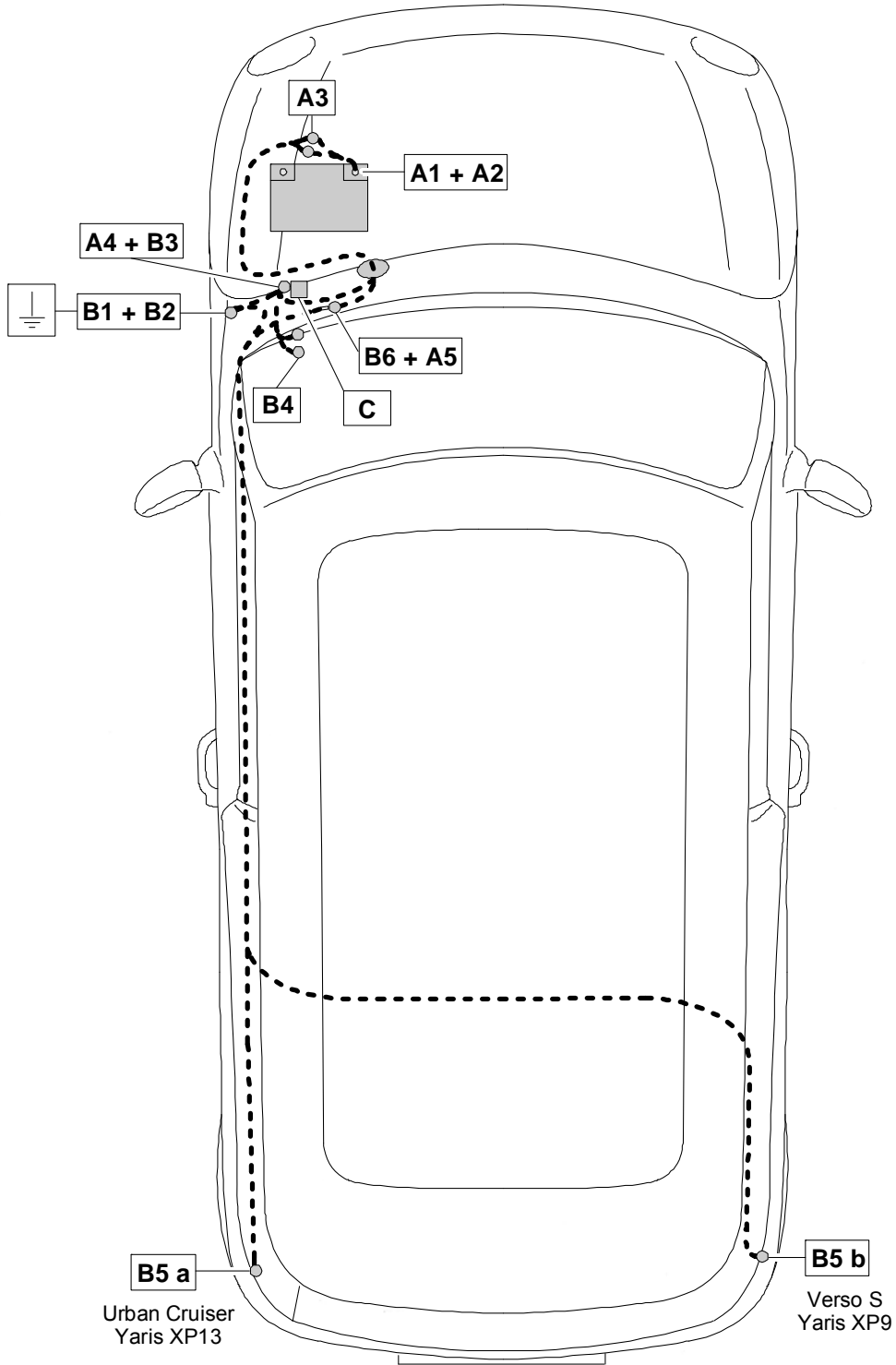



Verlegebeispiel / Routing

Avensis T25 Sedan

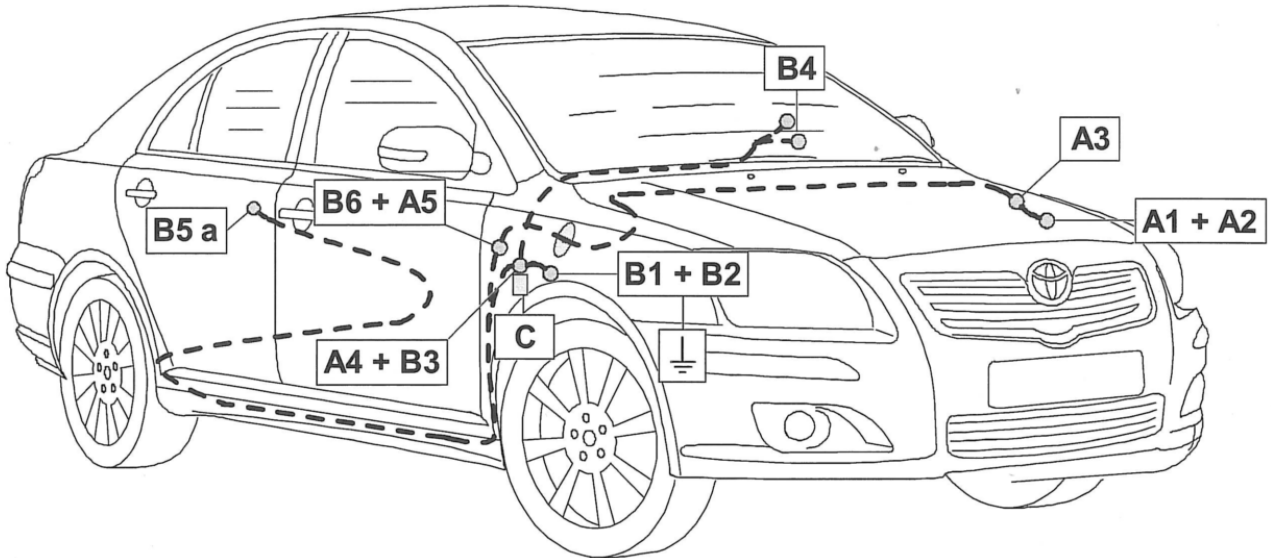

Avensis T25 Wagon

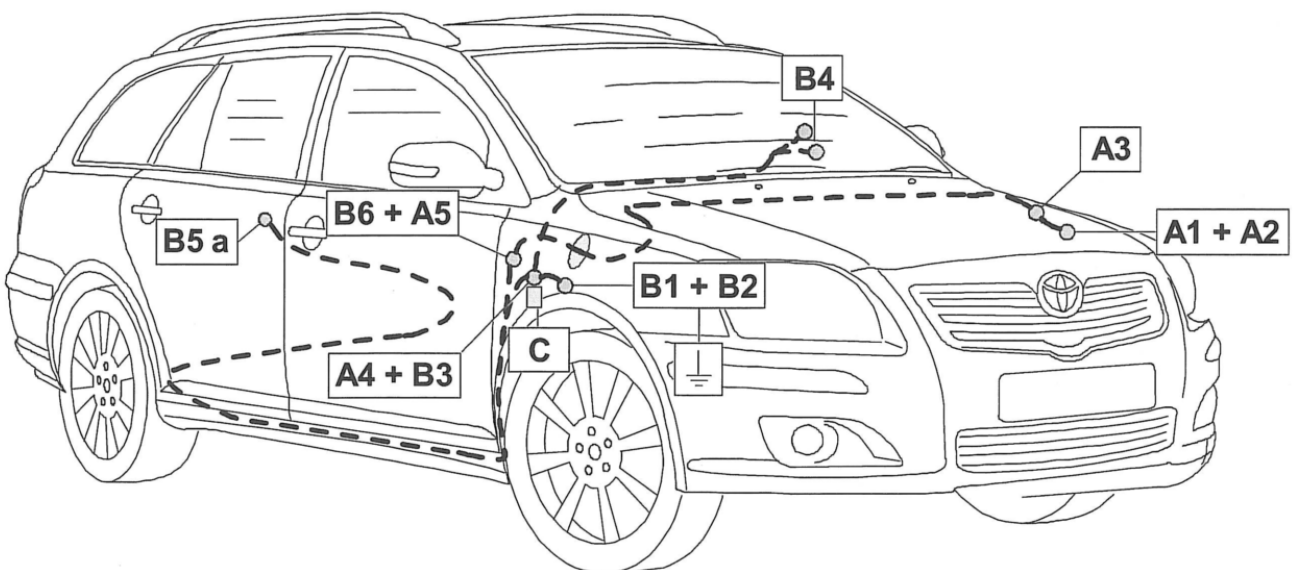



Verlegebeispiel / Routing

Hiace

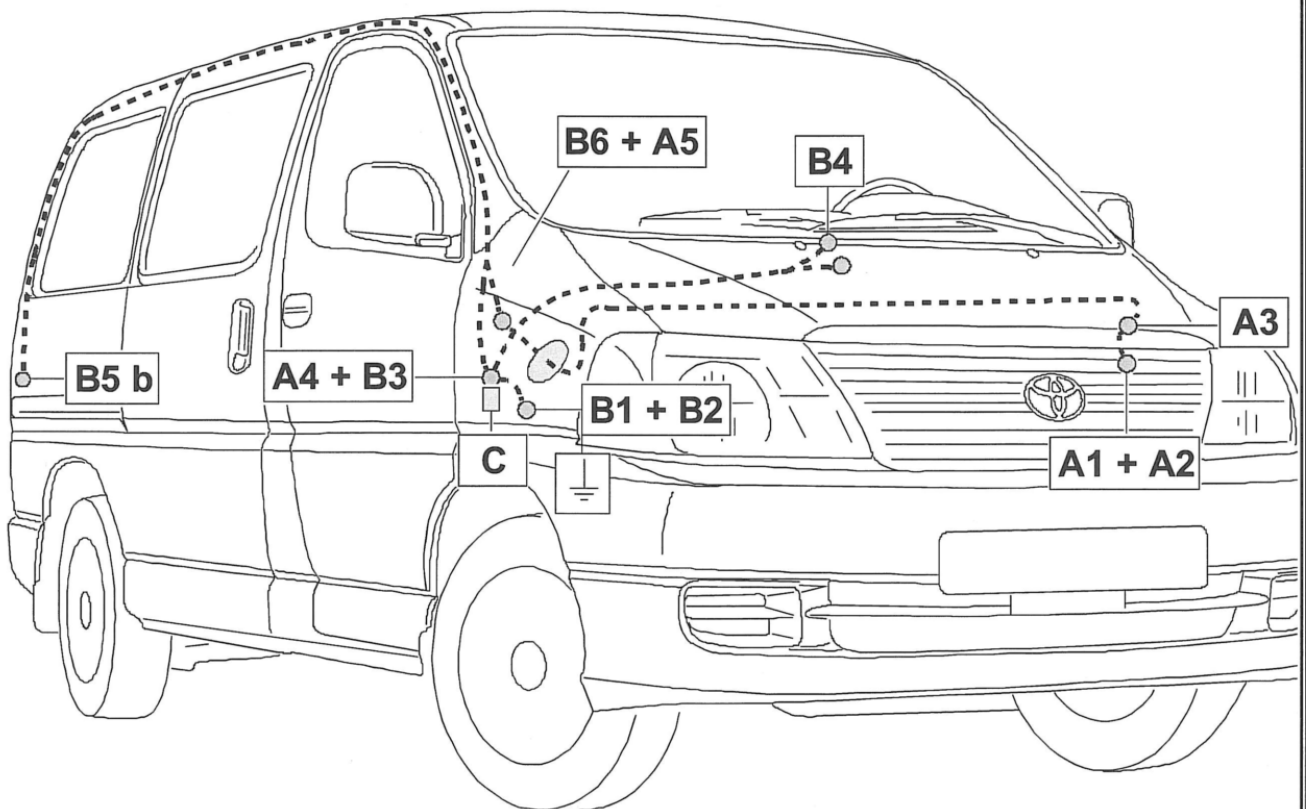



Verlegebeispiel / Routing

Auris

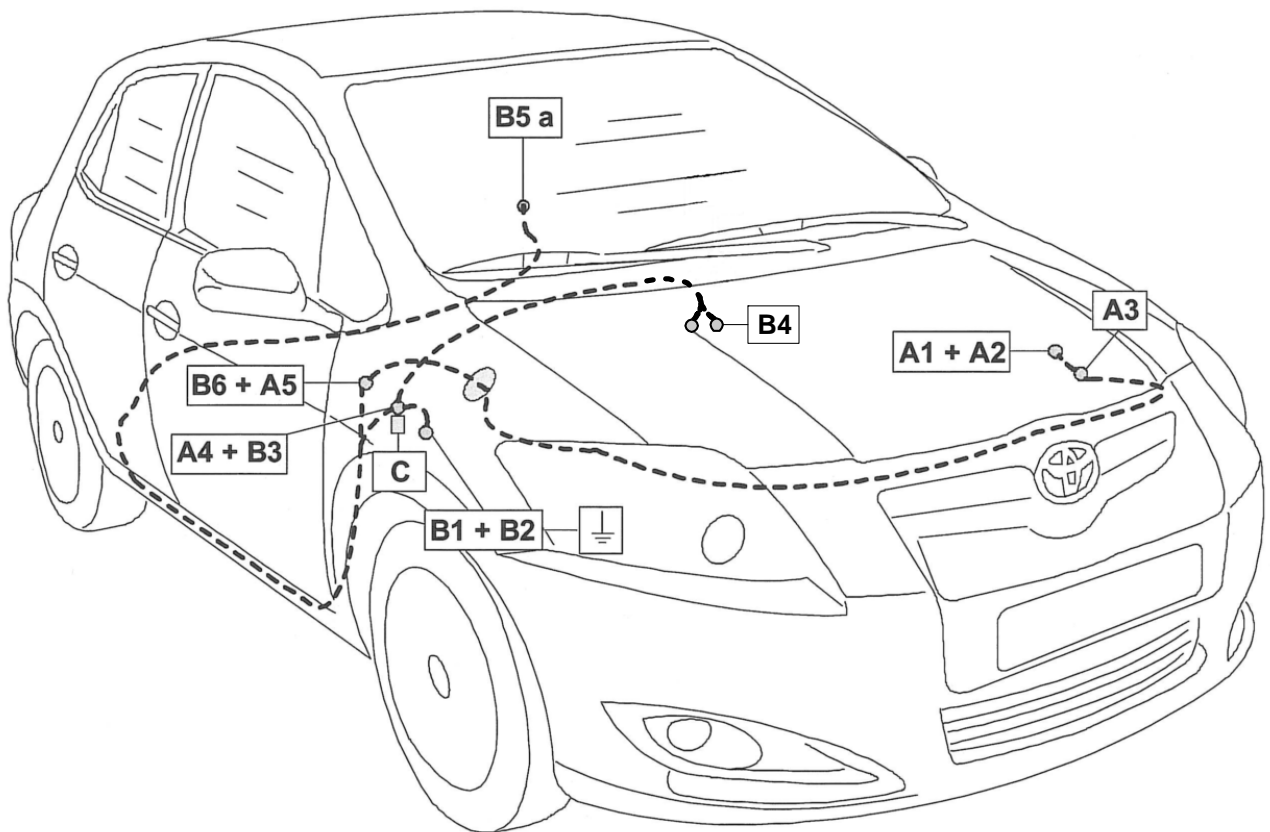



Verlegebeispiel / Routing

Corolla Verso

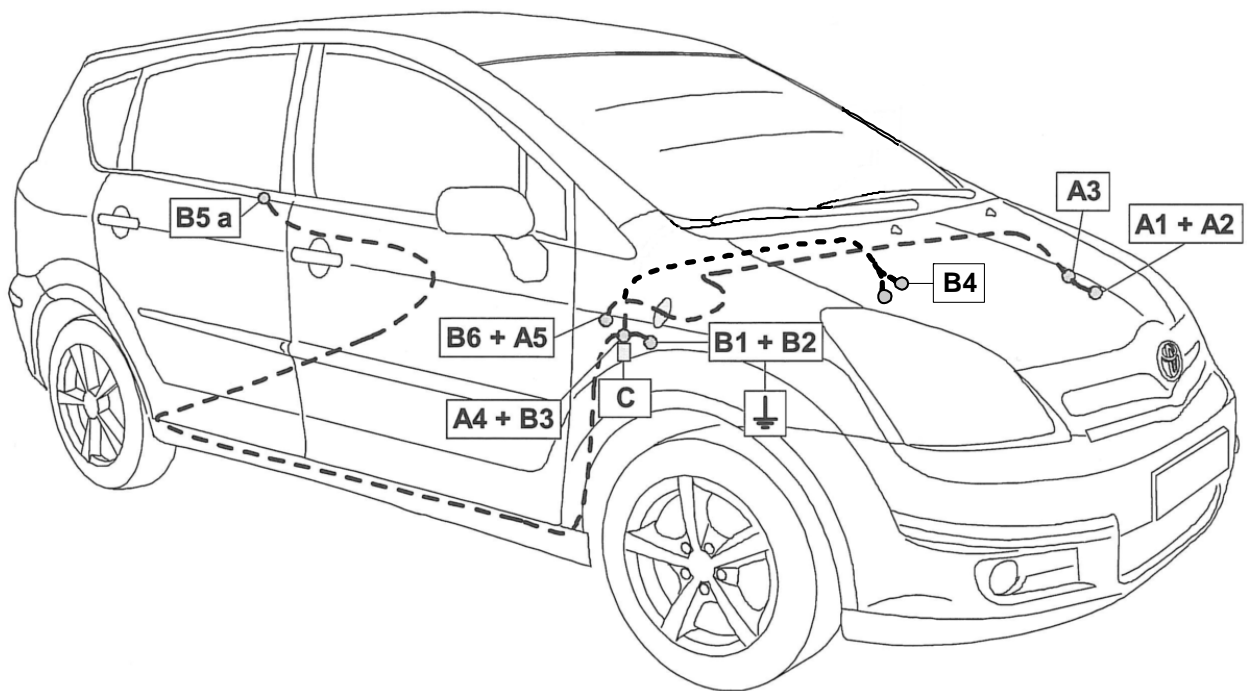



Verlegebeispiel / Routing

Verso S

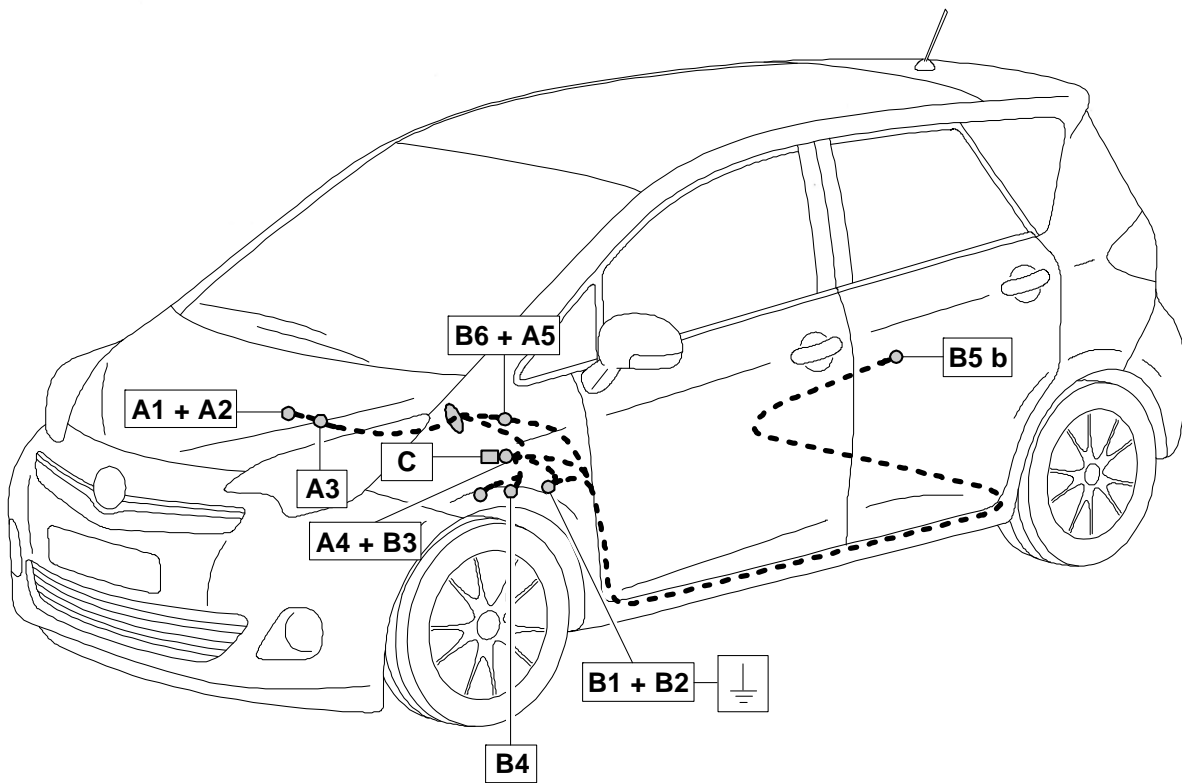



Verlegebeispiel / Routing

Urban Cruiser

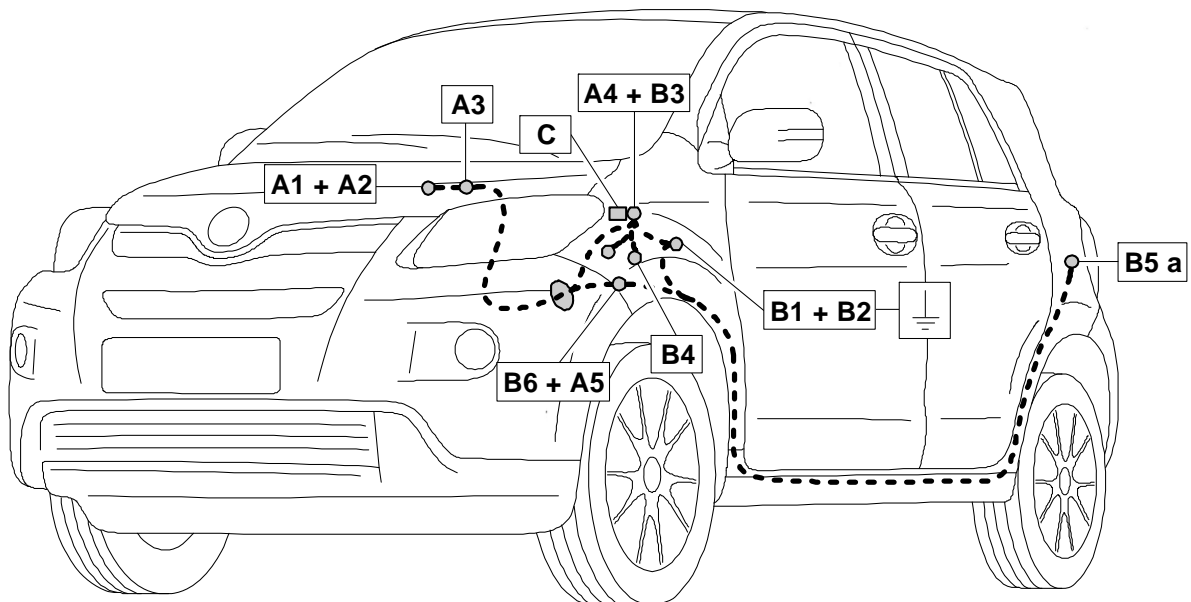



Verlegebeispiel / Routing

Verso

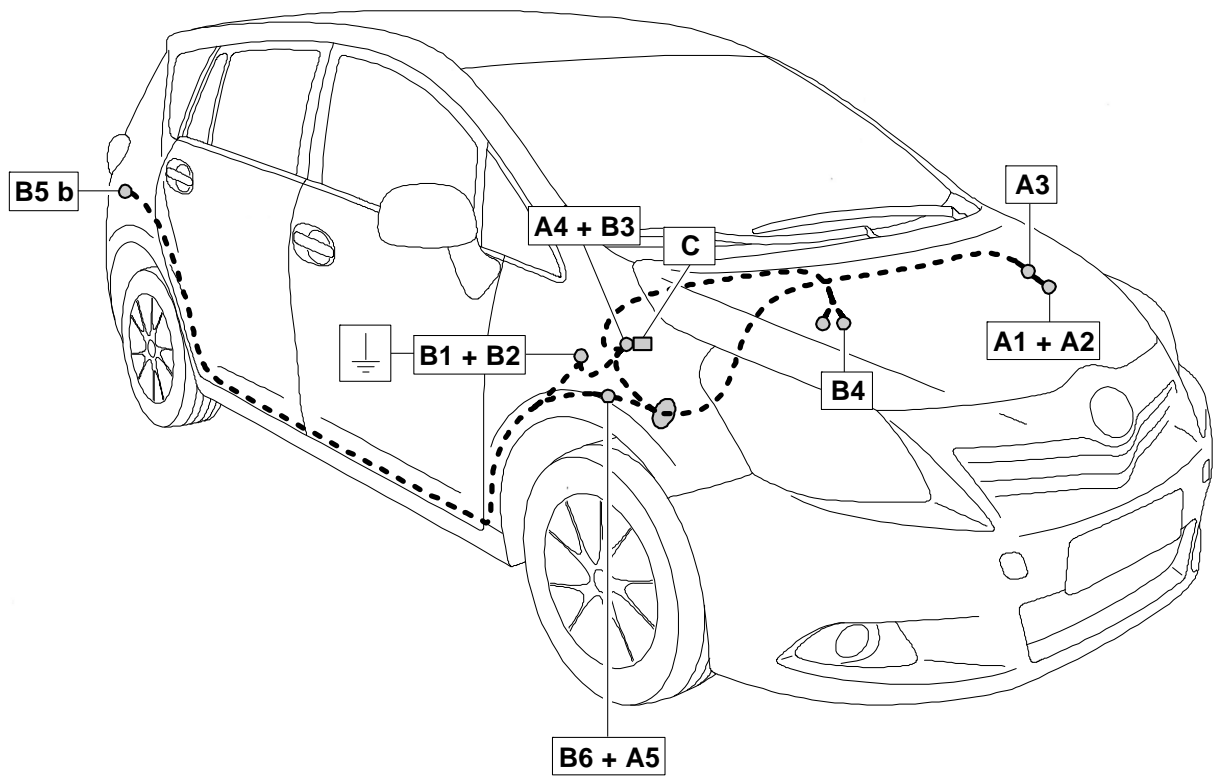



Verlegebeispiel / Routing

Yaris XP9

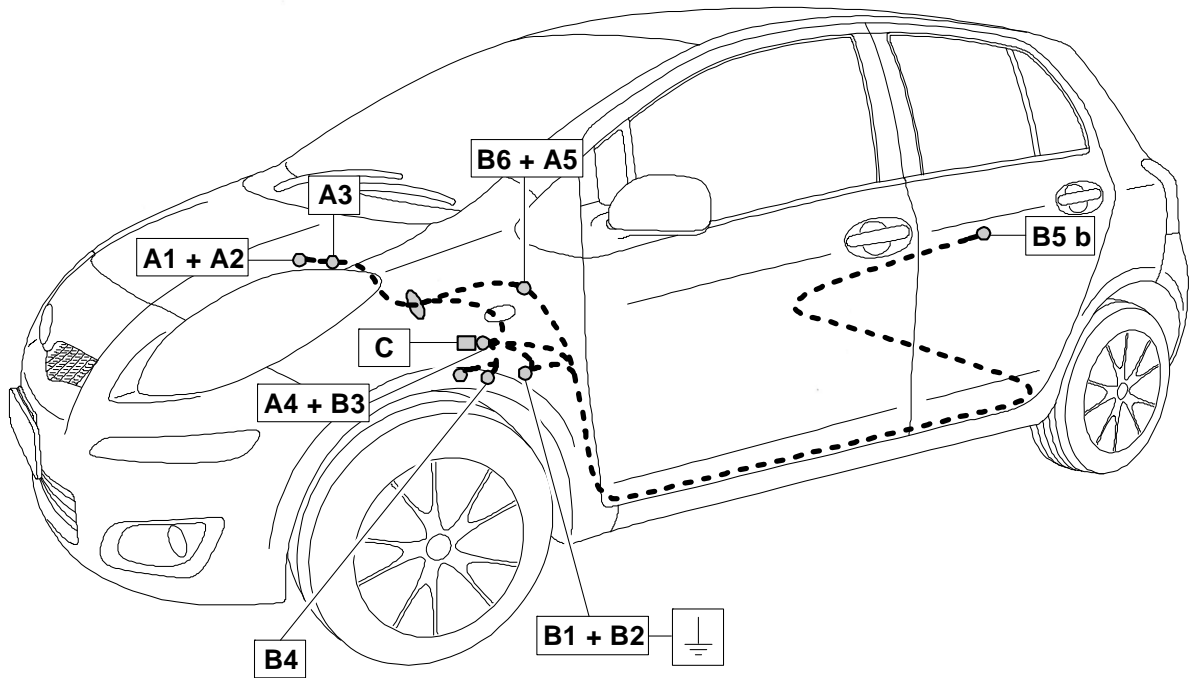

Yaris XP13

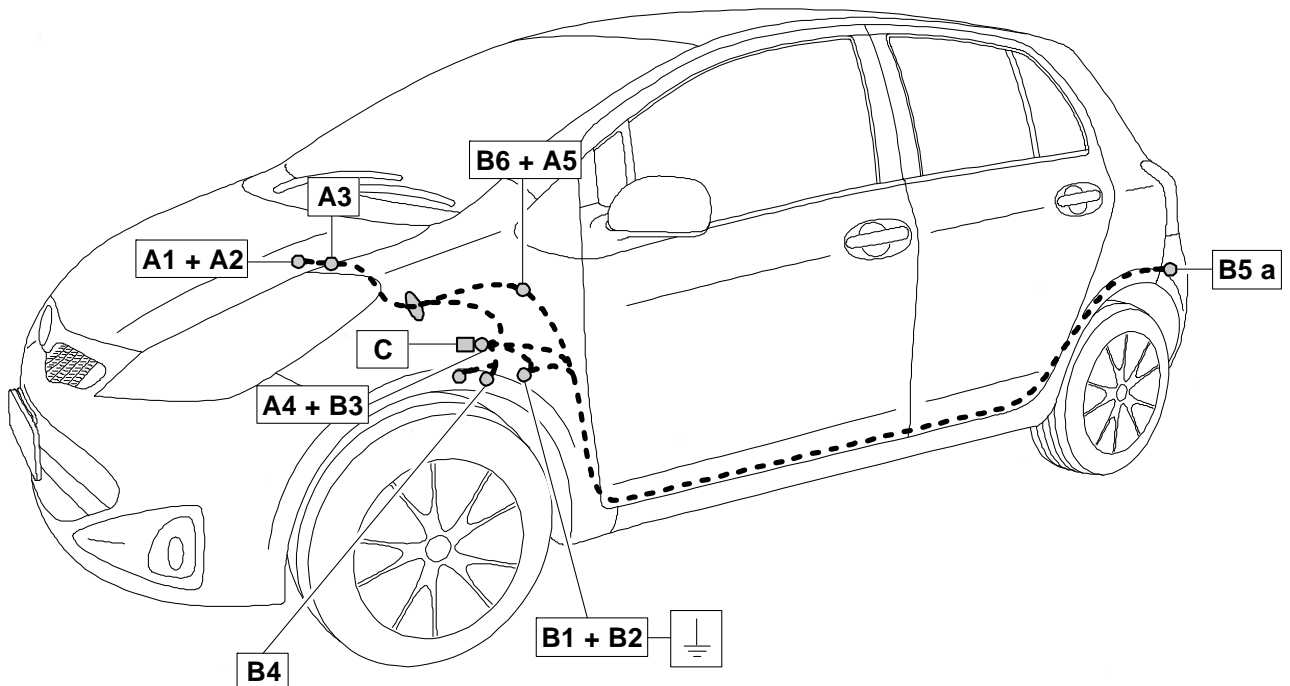

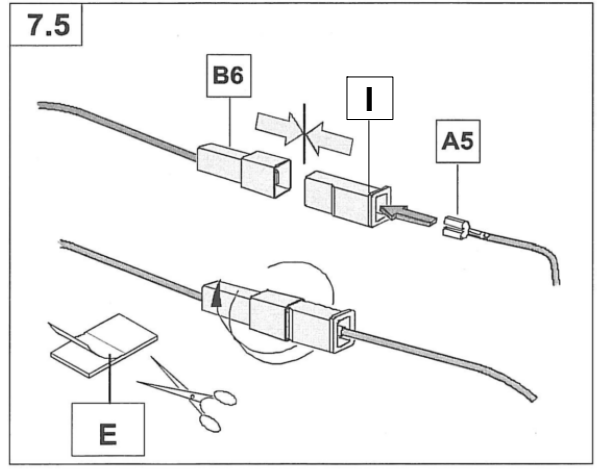
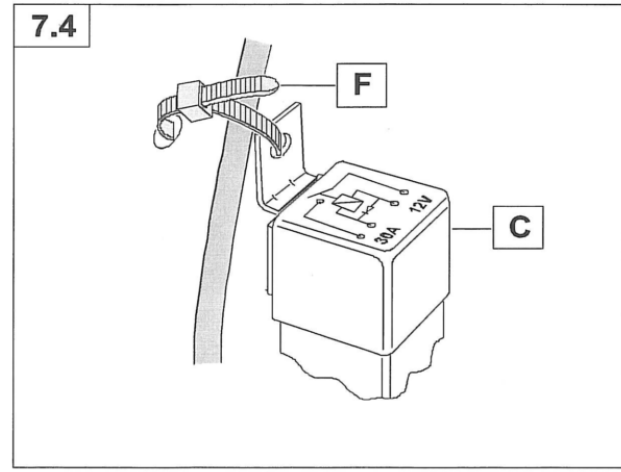
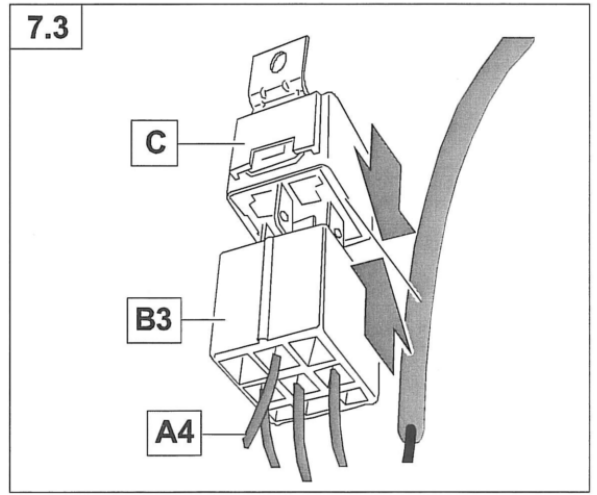
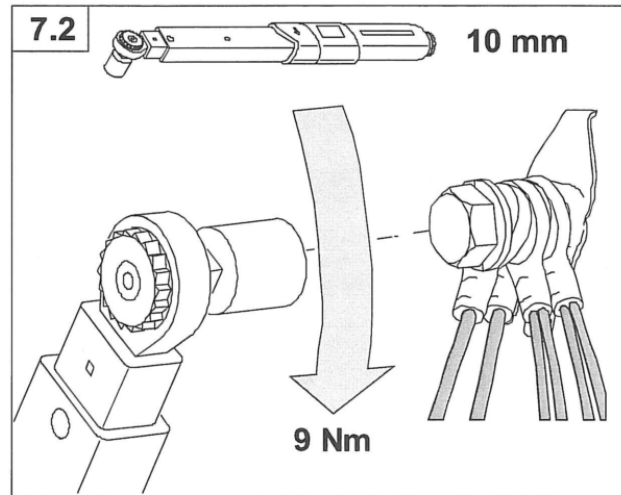
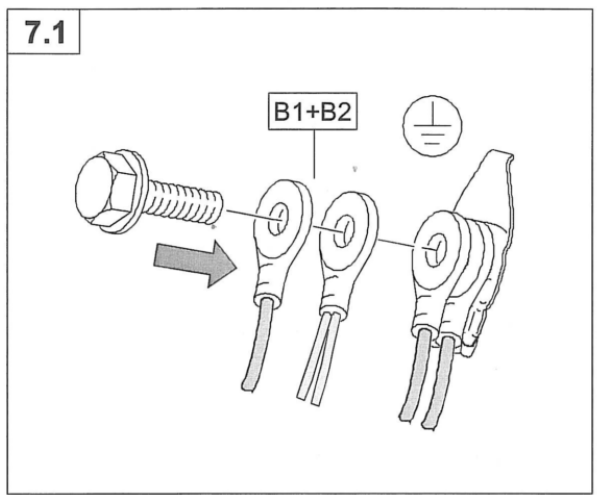
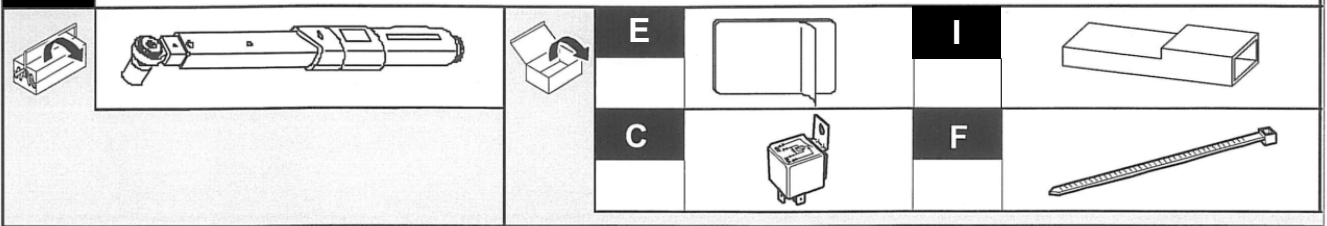

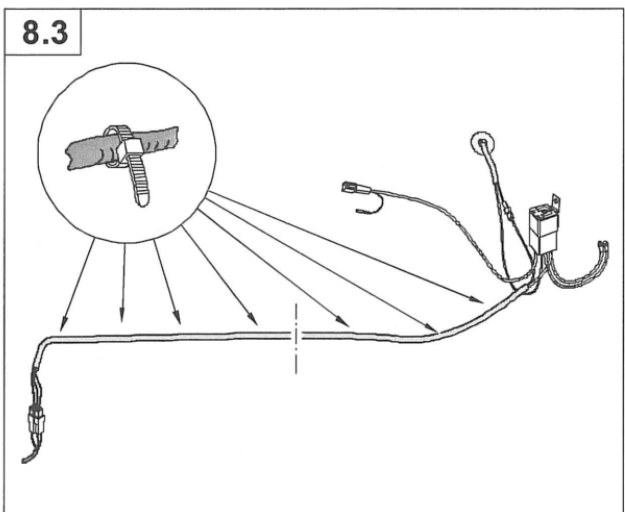
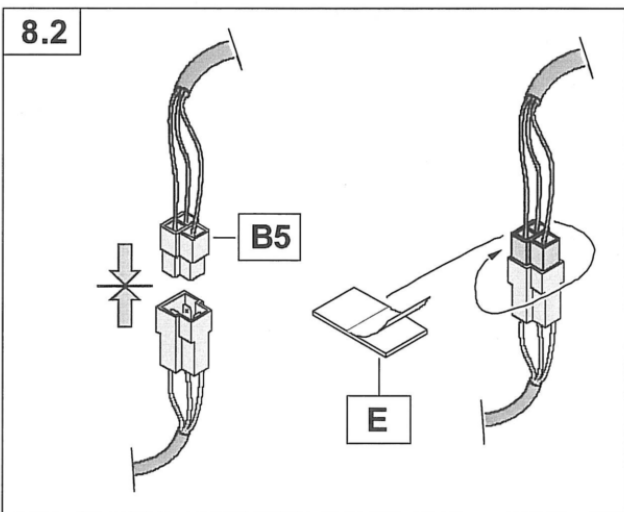
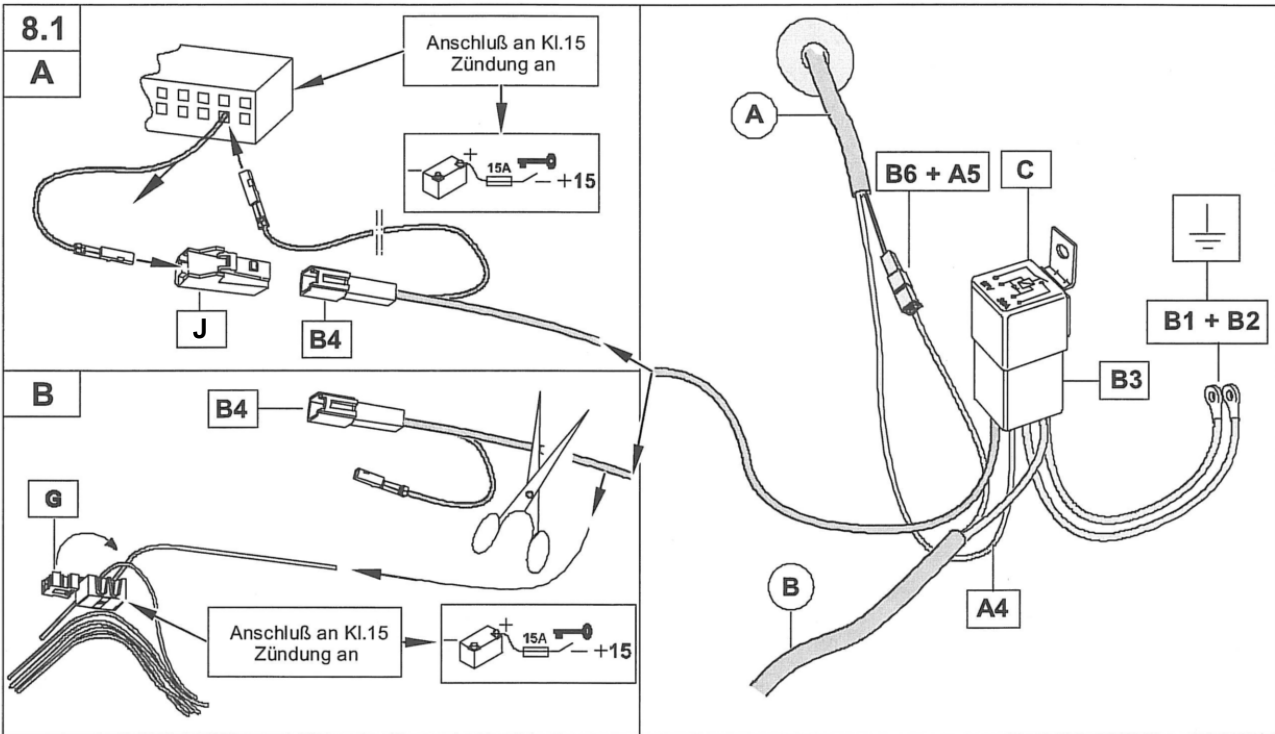
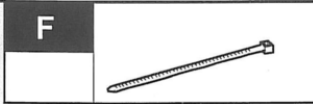
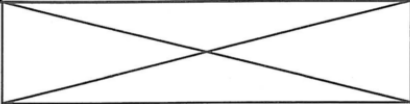

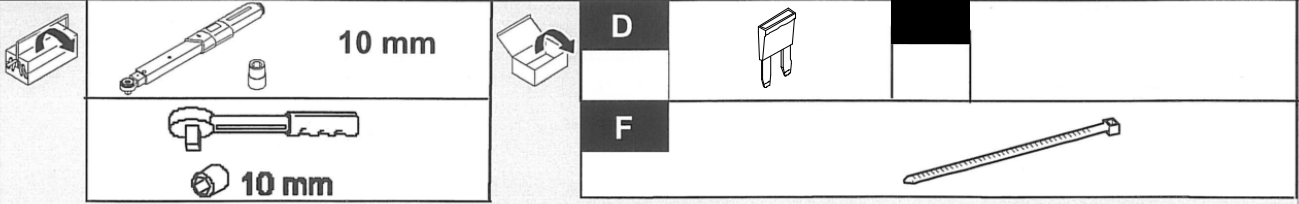

9.1

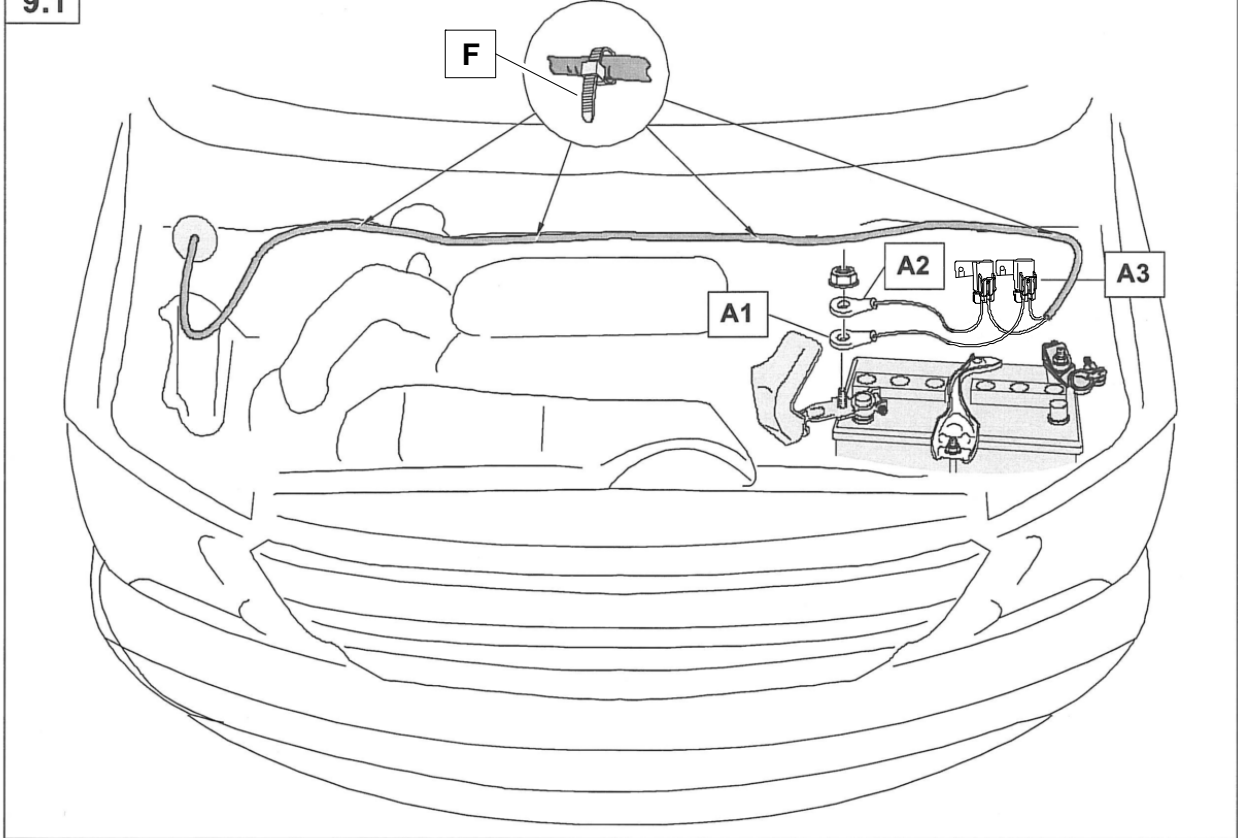

9.2

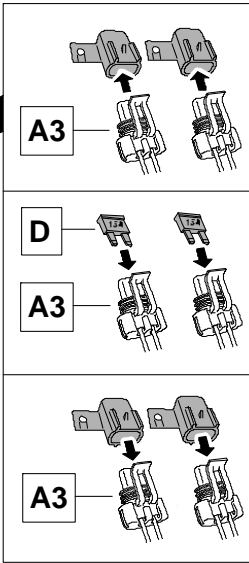
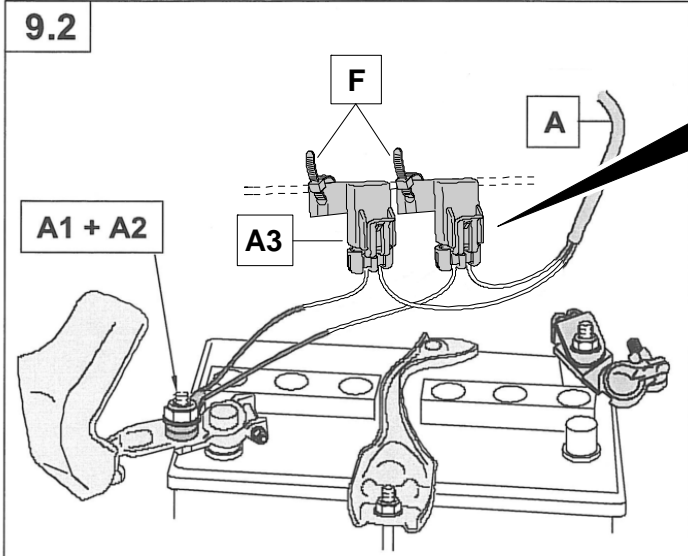

15



10.1

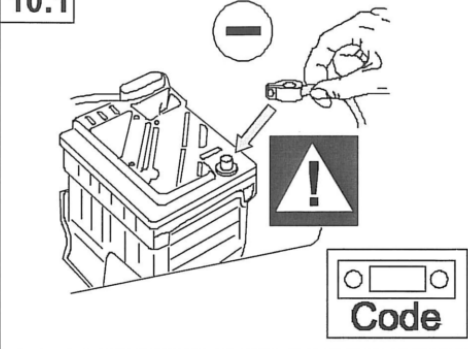

10.2

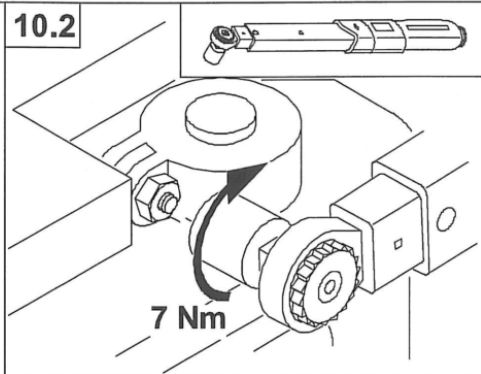

16



11.1

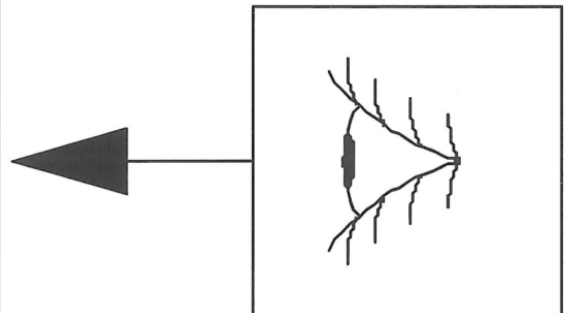
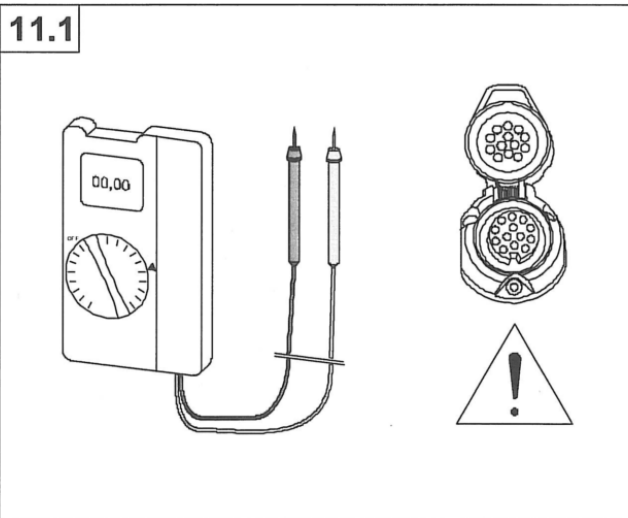

Funktionen kontrollieren / Check function